









TECHNICAL DATA SHEET



Silver Alu Jar

 Capacity	50 g
 Diameter	58 mm
 Height	24 mm
 Weight	≈ 10g
 Shape	Round
 Color (jar)	Silver
 Color (lid)	Silver
 Material (jar)	Aluminium
 Material (lid)	Aluminium

TECHNICAL DATA SHEET

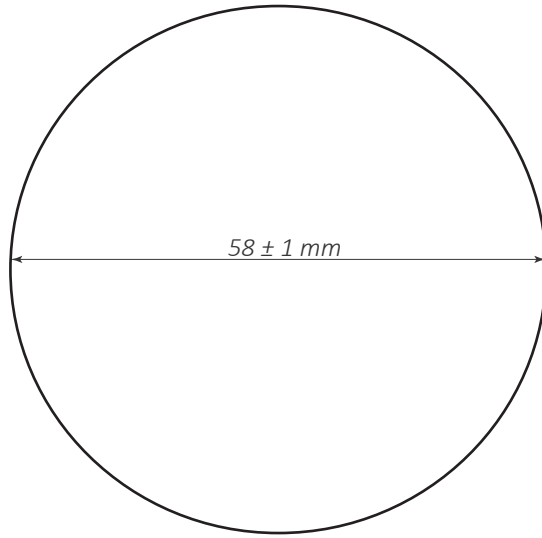
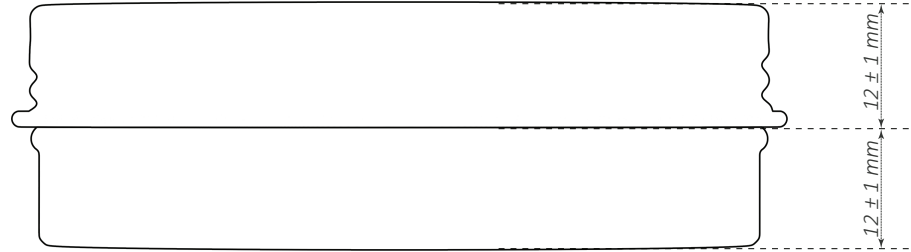

TOP VIEW

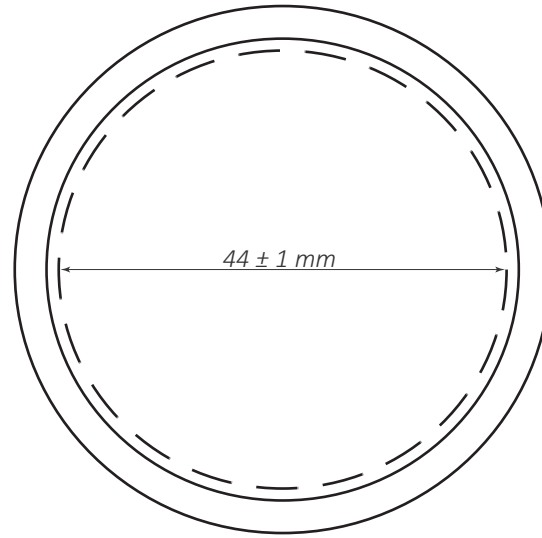

BOTTOM VIEW