









# TECHNICAL DATA SHEET



## Silver Alu Jar

 Capacity	30 g
 Diameter	51 mm
 Height	20 mm
 Weight	≈ 8g
 Shape	Round
 Color (jar)	Silver
 Color (lid)	Silver
 Material (jar)	Aluminium
 Material (lid)	Aluminium

# TECHNICAL DATA SHEET

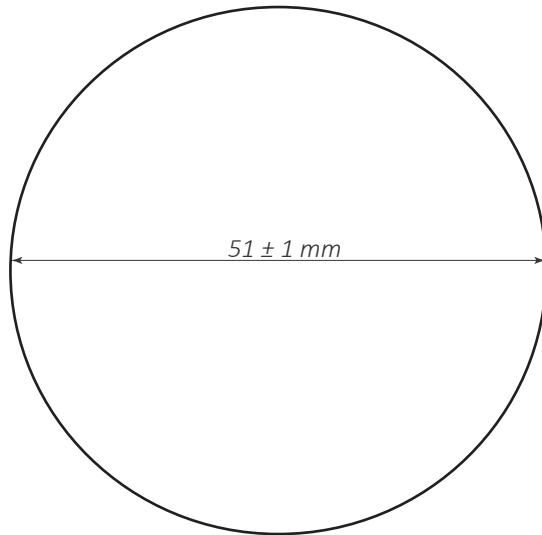
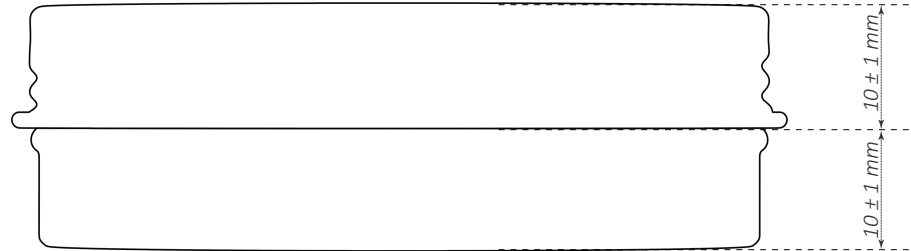

\*TOP VIEW\*

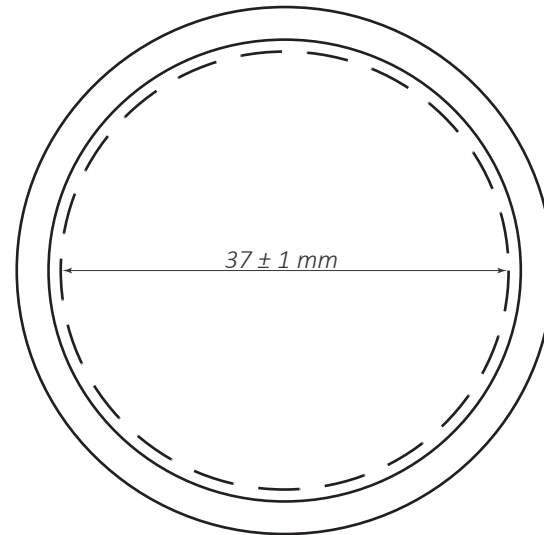

\*BOTTOM VIEW\*