







# TECHNICAL DATA SHEET



## Gold Alu Jar

 Capacity	50 g
 Diameter	58 mm
 Height	24 mm
 Weight	≈ 10g
 Shape	Round
 Color (jar)	Gold
 Color (lid)	Gold
 Material (jar)	Aluminium
 Material (lid)	Aluminium

# TECHNICAL DATA SHEET

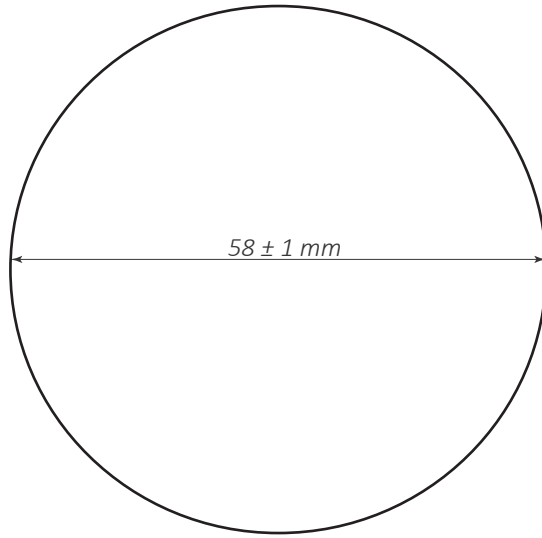
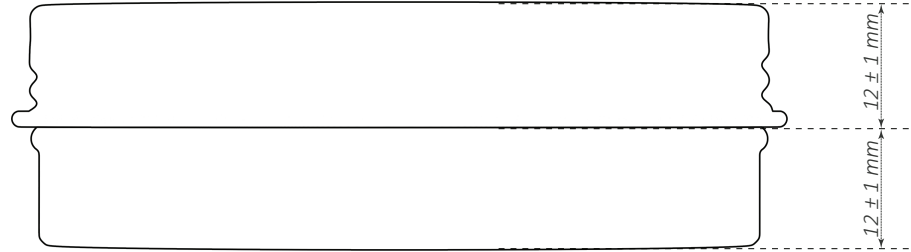

\*TOP VIEW\*

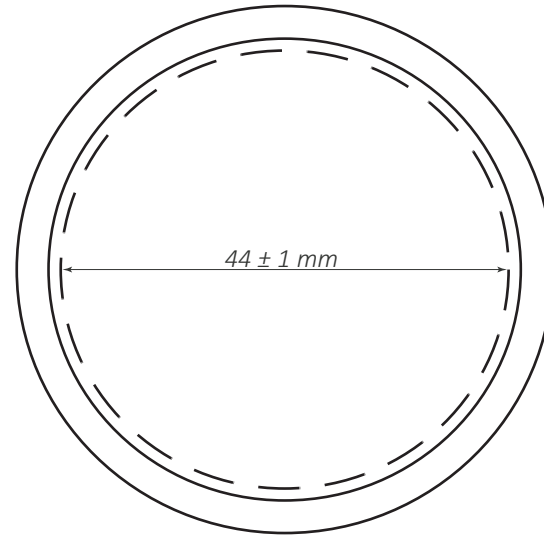

\*BOTTOM VIEW\*